



S100

The universal miniature photoelectric sensor

- Two threaded front mounting holes
- Two slotted rear mounting holes
- Anti-tampering sensor (no adjustment)
- Standard optic functions
- M8 connector and cable models
- PNP or NPN models with LIGHT/DARK selection by wire
- Plastic housing, IP67 mechanical protection



SENSORS

APPLICATIONS

- Processing and packaging machines
- Conveyors
- Automatic warehousing
- Intralogistic lines



S100		
Through beam		12 m
Retroreflective		7 m
Polarized Retroreflective (long range)		5,5 m
Polarized Retroreflective (short range)		3 m
Diffused proximity (short range)		300 mm
Diffused proximity (long range)		500 mm
Fixed focus		70 mm
Background suppression		30...100 mm
Power supply	Vdc	10...30 Vdc
Output	PNP	▪
	NPN	▪
Connection	cable	2 m cable, 4 wires
	connector	M8 conn., 4-pole
Approximate dimensions (mm)		32x20x12
Housing material		Plastic
Mechanical protection		IP67

CONNECTIONS

M8 CONNECTOR

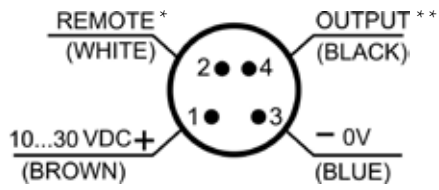

CABLE

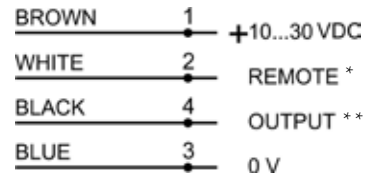

*REMOTE: Light/Dark selection (S100-...-A-B-C-D-F), External Teach-in (S100-...-M)
 **OUTPUT: PNP or NPN depends on the model

INDICATORS AND SETTINGS

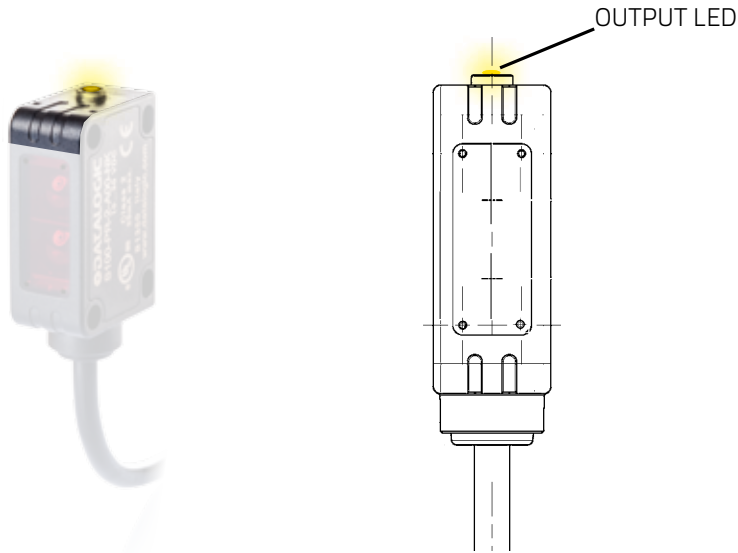

DETECTION DIAGRAMS

THROUGH BEAM

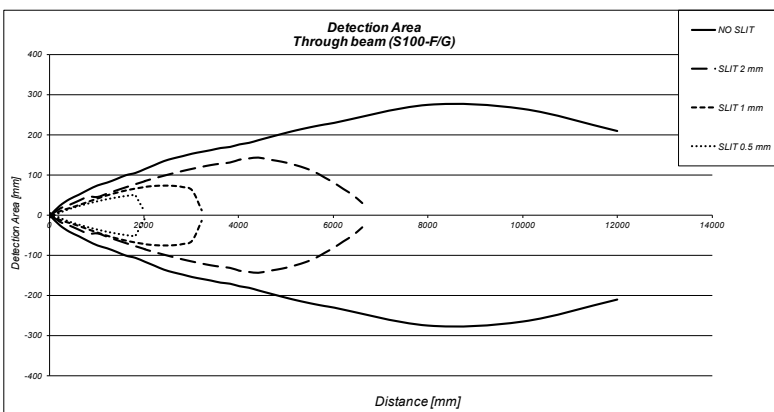

	max. operating distance
NO SLIT	12 m
2 mm SLIT	6,7 m
1 mm SLIT	3,2 m
0,5 mm SLIT	2 m

DIFFUSE PROXIMITY

	SHORT RANGE (S100-...-C0)	LONG RANGE (S100-...-C1)
Recommended operating distance (on White 90% target)	10...240 mm	2...400 mm
Maximum operating distance (White 90% target)	1...300 mm	0...500 mm
Maximum operating distance (Grey 18% target)	20...150 mm	10...280 mm
Maximum operating distance (Black 6% target)	30...80 mm	20...160 mm
Difference White-Grey	50%	50%
Difference White-Black	75%	75%
Hysteresis	20%	20%

DIFFUSE (SHORT RANGE: S100-C00)

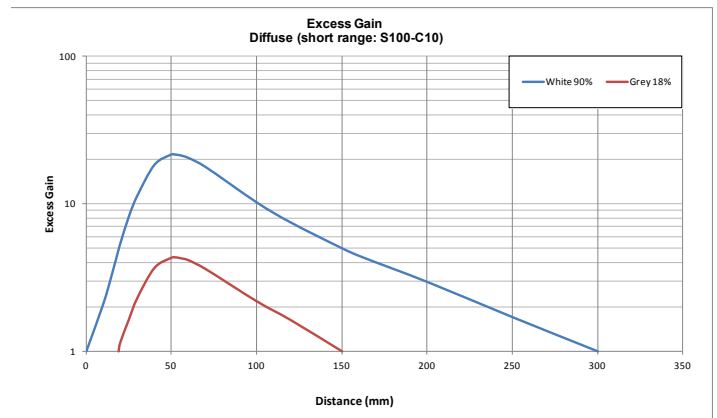
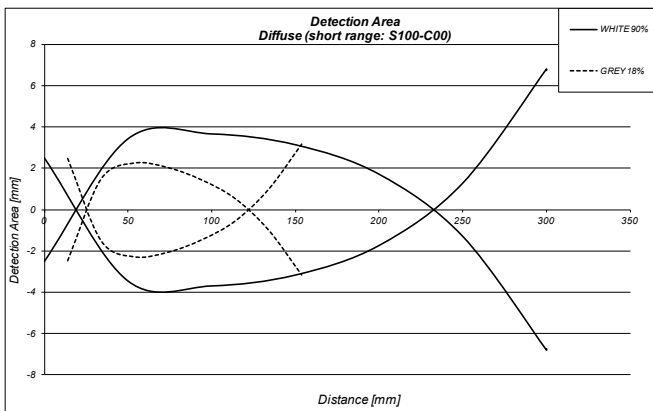

DIFFUSE (LONG RANGE: S100-C10)

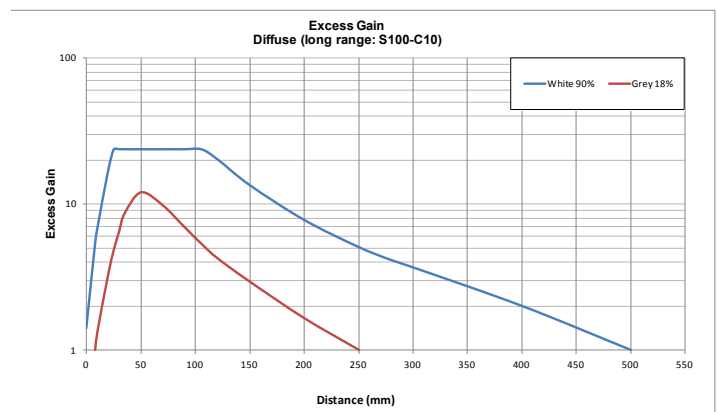
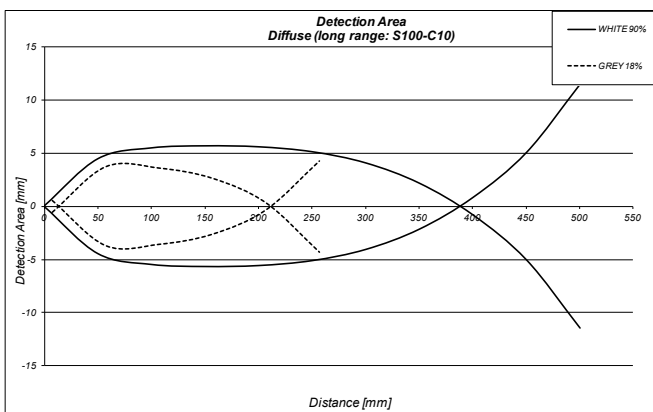

POLARIZED RETROREFLECTIVE

REFLECTOR	TYPE	SHORT RANGE (S100-...-B00)	LONG RANGE (S100-...-B10)
R1	circular (23 mm)	0,2..0,8 m	0,02..2 m
R2	circular (48 mm)	0,03..2 m	0,01..4,5 m
R3	rectangular (18x54 mm)	0,03..1,5 m	0,01..3 m
R4	rectangular (47x47 mm)	0,03..2,5 m	0,01..4,5 m
R5	circular (75 mm)	0,01..3 m	0,01..5,5 m
R6	rectangular (36x55 mm)	0,03..1,8 m	0,01..4 m
RT3970	self-adhesive tape (60x40 mm)	0,2..0,8 m	0,05..1,8 m



	max. operating distance			
	SHORT RANGE (S100-...-B00)		LONG RANGE (S100-...-B10)	
	with R5 reflector	with R2 reflector	with R5 reflector	with R2 reflector
NO SLIT	0,02 ... 3 m	0,02 ... 2 m	0,1...5,5 m	0,01...4,5 m
2 mm SLIT	0,05 ... 1,5 m	0,05 ... 0,8 m	0,2...4 m	0,03...3 m
1 mm SLIT	-	-	0,3...2,5 m	0,05...1,5 m
0,5 mm SLIT	-	-	0,5...1,2 m	0,07...0,7 m

POLARIZED RETROREFLECTIVE (SHORT RANGE: S100-B00)

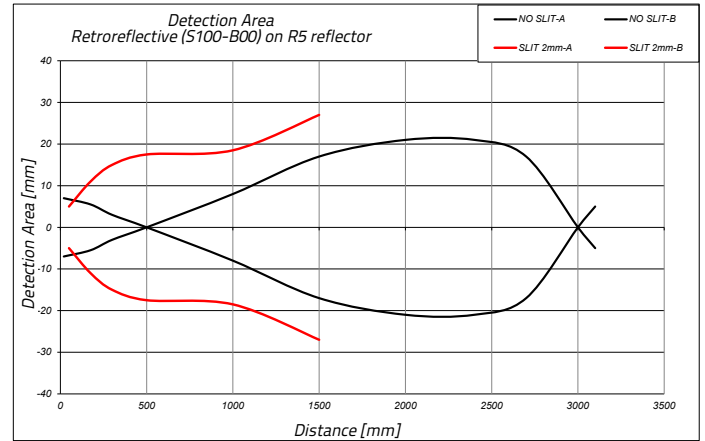
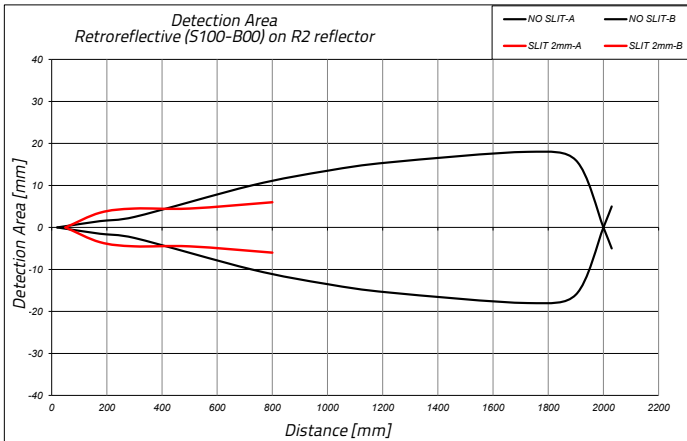

POLARIZED RETROREFLECTIVE (LONG RANGE: S100-B10)

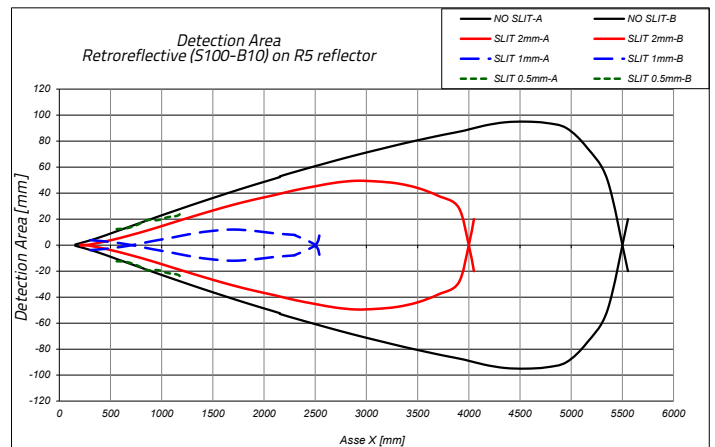
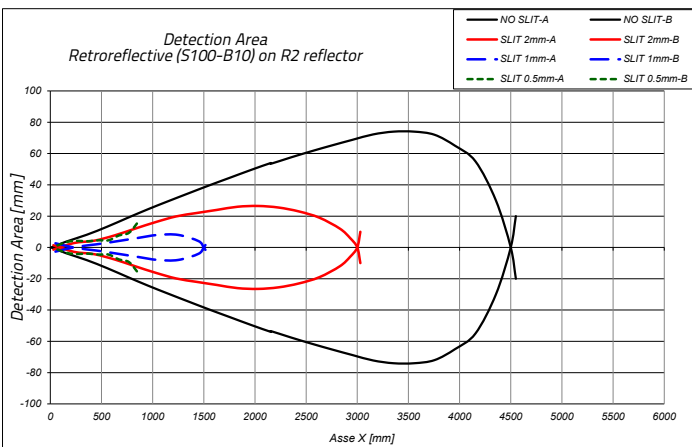

RETROREFLECTIVE (infrared)

REFLECTOR	TYPE	(S100-...-A00)
R1	circular (23 mm)	0.03..3 m
R2	circular (48 mm)	0.01..6 m
R3	rectangular (18x54 mm)	0.01..3.5 m
R4	rectangular (47x47 mm)	0.01..5 m
R5	circular (75 mm)	0.01..7 m
R6	rectangular (36x55 mm)	0.01..6 m
RT3970	self-adhesive tape (60x40 mm)	0,05..2 m



	max. operating distance	
	with R5 reflector	with R2 reflector
NO SLIT	7 m	6 m
2 mm SLIT	4,7 m	3,4 m
1 mm SLIT	2,7 m	2,3 m
0,5 mm SLIT	1,5 m	1 m

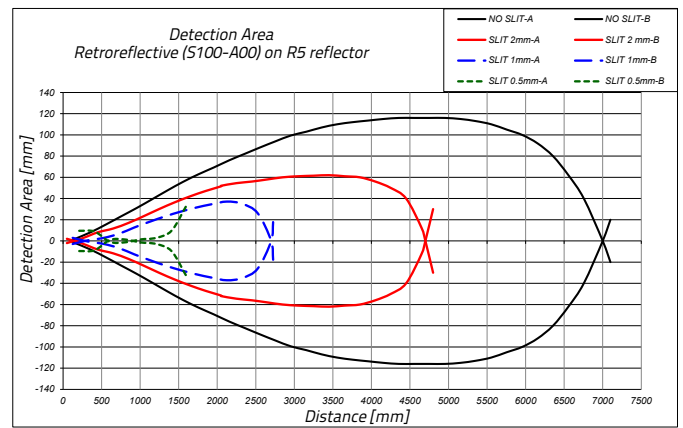
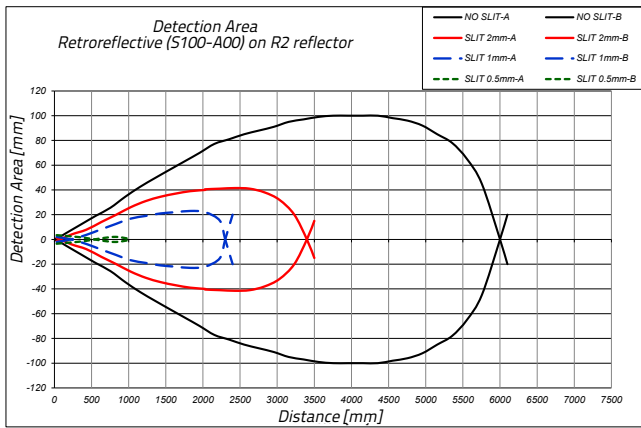

FIXED FOCUS

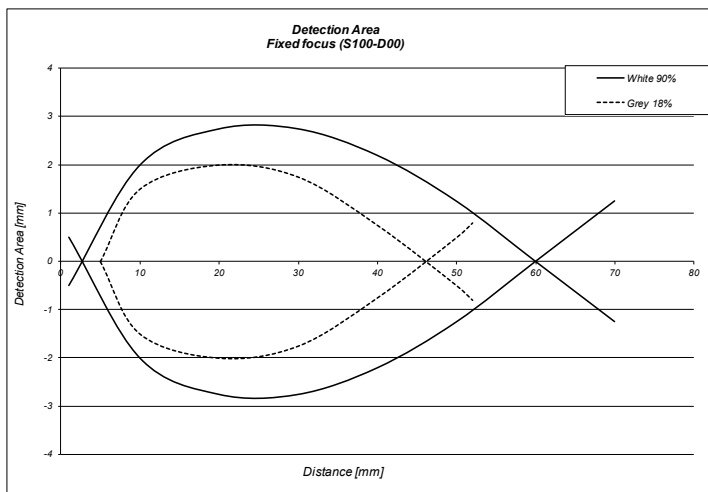

Focus point	70 mm
Maximum operating distance (White 90%)	70 mm
Maximum operating distance (Grey 18%)	55 mm
Difference White/Black	25%

BACKGROUND SUPPRESSION

Operating distances (background suppression)	30...100 mm
Maximum operating distance (White 90%)	0...150 mm
Maximum operating distance (Grey 18%)	4...110 mm
Maximum operating distance (Black 6%)	5...80 mm
Difference White 90%/White 90%	< 5%
Difference White 90%/Grey 18%	< 15%
Difference White 90%/Black 6%	< 25%

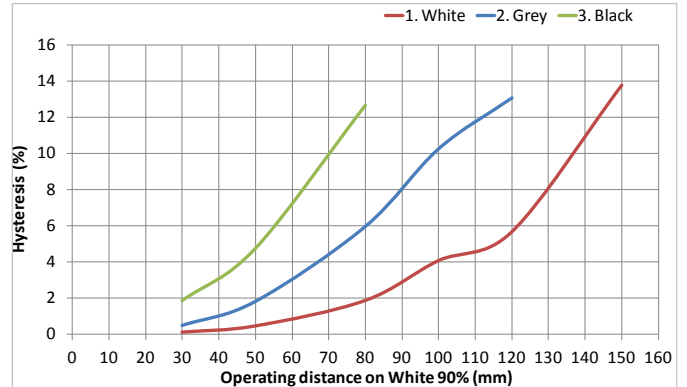
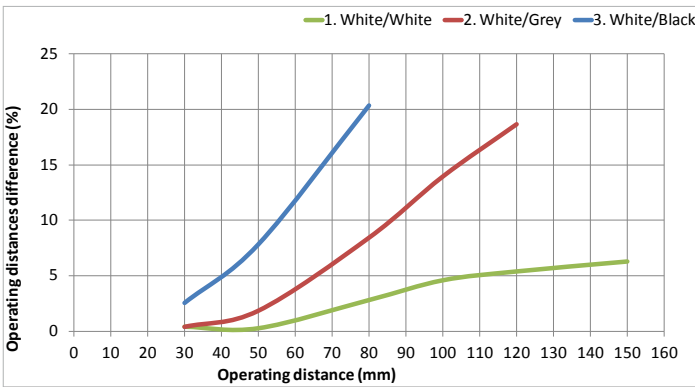

MODEL SELECTION AND ORDER INFORMATION

OPTIC FUNCTION	EMISSION	OPERATING DISTANCE	CONNECTION	OUTPUT	MODEL	ORDER No.
Through beam	IR	12 m	2 m cable	NPN	S100-PR-2-FG00-NK	950811100
				PNP	S100-PR-2-FG00-PK	950811110
			M8 connector	NPN	S100-PR-5-FG00-NK	950811240
				PNP	S100-PR-5-FG00-PK	950811250
Retroreflective	IR	7 m	2 m cable	NPN	S100-PR-2-A00-NK	950811000
				PNP	S100-PR-2-A00-PK	950811010
			M8 connector	NPN	S100-PR-5-A00-NK	950811140
				PNP	S100-PR-5-A00-PK	950811150
Polarized Retroreflective (short)	RED	2 m	2 m cable	NPN	S100-PR-2-B00-NK	950811020
				PNP	S100-PR-2-B00-PK	950811030
			M8 connector	NPN	S100-PR-5-B00-NK	950811160
				PNP	S100-PR-5-B00-PK	950811170
Polarized Retroreflective (long)	RED	5 m	2 m cable	NPN	S100-PR-2-B10-NK	950811280
				PNP	S100-PR-2-B10-PK	950811290
			M8 connector	NPN	S100-PR-5-B10-NK	950811300
				PNP	S100-PR-5-B10-PK	950811310
Diffuse proximity (short)	RED	300 mm	2 m cable	NPN	S100-PR-2-C00-NK	950811040
				PNP	S100-PR-2-C00-PK	950811050
			M8 connector	NPN	S100-PR-5-C00-NK	950811180
				PNP	S100-PR-5-C00-PK	950811190
Diffuse proximity (long)	RED	500 mm	2 m cable	NPN	S100-PR-2-C10-NK	950811060
				PNP	S100-PR-2-C10-PK	950811070
			M8 connector	NPN	S100-PR-5-C10-NK	950811200
				PNP	S100-PR-5-C10-PK	950811210
Fixed focus	RED	70 mm	2 m cable	NPN	S100-PR-2-D00-NK	950811080
				PNP	S100-PR-2-D00-PK	950811090
			M8 connector	NPN	S100-PR-5-D00-NK	950811220
				PNP	S100-PR-5-D00-PK	950811230
Background suppression	RED	30...100 mm	2 m cable	NPN	S100-PR-2-M00-NH	950811120
				PNP	S100-PR-2-M00-PH	950811130
			M8 connector	NPN	S100-PR-5-M00-NH	950811260
				PNP	S100-PR-5-M00-PH	950811270

ACCESSORIES

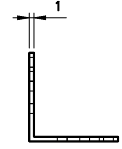
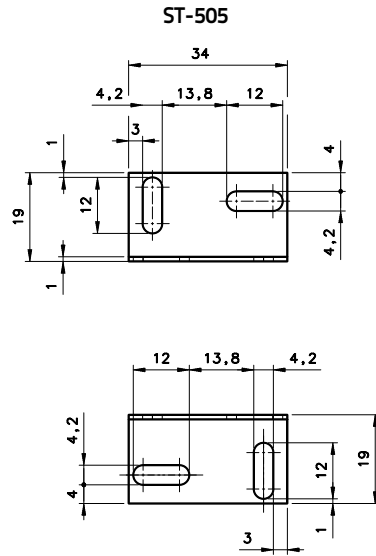
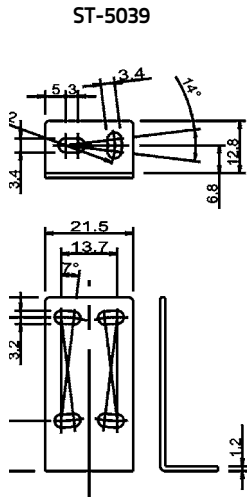

M18 ADAPTER NOSE



SLIT

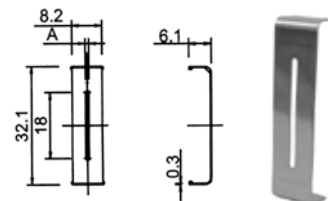

TYPE	MODEL	DESCRIPTION	Order No.
Mounting bracket	ST-505	lateral mounting	95ACC2800
	ST-5039	L-shaped bracket	95ACC2270
Slit	S100-SLIT-05	0,5x19 mm SLIT	95ACC3450
	S100-SLIT-1	1x19 mm SLIT	95ACC3460
	S100-SLIT-2	2x19 mm SLIT	95ACC3470
M18 adapter	ST-S3Z-M18	M18 THREADED ADAPTER NOSE	95ACC7850

CABLES

TYPE	DESCRIPTION	LENGTH	MODEL	ORDER No.
Axial M8 Connector	4-pole, grey, P.V.C.	3 m	CS-B1-02-G-03	95A251420
		5 m	CS-B1-02-G-05	95A251430
		7 m	CS-B1-02-G-07	95A251440
		10 m	CS-B1-02-G-10	95A251480
Radial M8 Connector	4-pole, P.U.R.	2 m	CS-B1-02-R-02	95A251620
		5 m	CS-B1-02-R-05	95A251640
	4-pole, grey, P.V.C.	3 m	CS-B2-02-G-03	95A251450
		5 m	CS-B2-02-G-05	95A251460
		7 m	CS-B2-02-G-07	95A251470
4-pole, P.U.R.	10 m	CS-B2-02-G-10	95A251530	
	2 m	CS-B2-02-R-02	95A251630	
5 m	CS-B2-02-R-05	95A251650		