

US30 SERIES

The range of measurement and inspection devices is enriched thanks to the introduction of tubular standard M30x1 sensors of the **US30** series. Models with operating distances reaching 200 cm are available either with bipolar digital output (NPN/PNP NO/NC) or with 4-20 mA or 0-10 V analogue output. The sensors can be easily configured using the Teach-in function, while the operating status is visibly signalled by 3 LEDs. The temperature compensation function corrects the sound speed changes due to temperature variations, so the sensor precision remains unchanged in all situations and guarantees a resolution reaching 0.5 mm. The electrical connection is accomplished through standard M12 4-pole connectors. The **US30** ultrasonic sensors detect all objects independent from the non sound-absorbent material, reflectivity, transparency and colour, thus perfectly suiting applications in the automotive, packaging, machine tool fields and material transformation processes.



HIGHLIGHTS

- High precision and switching frequency
- Colour independence and transparent object detection
- Easy Teach-in setting and 3 signalling LEDs
- Models with digital NPN - PNP and 0 - 10 V or 4- 20 mA analogue outputs

APPLICATIONS

Ceramics

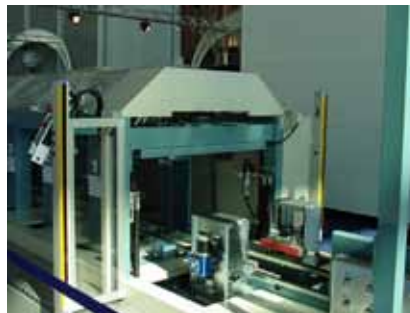

Beverage & Bottling



Transportation lines



Packaging lines



DIMENSIONS

Models with discrete output are excellent foreground and/or background suppressors. The Teach-in procedure allows to fix a switching window with 10 mm width or to detect minimum and maximum values. The models with analogue output are conceived as distance sensors: the analogue output can be scaled on windows of any width inside the operating range, or positioned at the centre of a detection window with a fixed width of 100 mm.

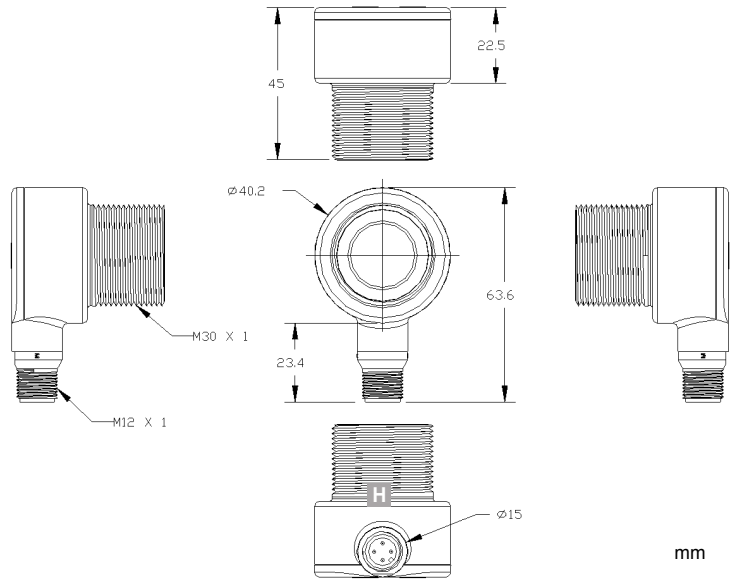

INDICATORS AND PUSH-BUTTONS



- A Output status LED
- B POWER ON LED
- C SIGNAL LED
- D MODE push-button
- E TEACH push-button

ACCESSORIES

For **dedicated accessories** refer to the **ACCESSORIES** section of this catalogue.

Refer also to **Connectors** of the **General Catalogue**.

CONNECTIONS

M12 4-POLE CONNECTOR

Analogue

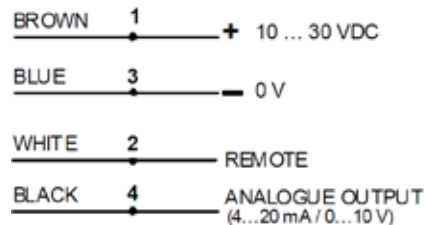

Digital

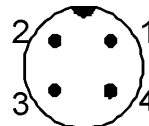
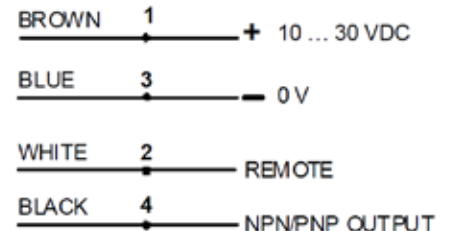

Versions and options: refer to **MODEL SELECTION TABLE**

TECHNICAL DATA

		US30-PR-5-N13-IH	US30-PR-5-N23-IH	US30-PR-5-N13-VH	US30-PR-5-N23-VH	US30-PR-5-N13-OH	US30-PR-5-N23-OH
Operating distance:	100 ... 1000 mm	•		•		•	
	200 ... 2000 mm		•		•		•
Power supply:	10 ... 30 Vdc (limit values),	•	•	•	•	•	•
	polarity inversion protection	•	•	•	•	•	•
Ripple:	≤ 2 Vpp	•	•	•	•	•	•
Consumption:	40 mA max. (output current excluded)	•	•	•	•	•	•
Output type:	bipolar digital NPN and PNP					•	•
	analogue 0...10 Vdc			•	•		
	analogue 4...20 mA	•	•				
Output current:	100 mA max., short-circuit protection					•	•
Saturation voltage:	PNP < 3 V @ 100 mA; NPN < 1.6 V @ 100 mA					•	•
Load resistance:	voltage output: 2,5 kΩmin.			•	•		
	current output: 1 kΩ @ 24 V	•	•				
Response time:	45 ... 92 ms selectable					•	•
	45 ... 105 ms selectable	•	•				
	92 ... 222 ms selectable		•	•			
Switching frequency:	11 ... 5.4 Hz			•	•		
	11 ... 4.7 Hz	•	•				
	5.4 ... 2.2 Hz		•	•			
Delay at powering:	500 ms	•	•	•	•	•	•
Indicators:	yellow OUT LED	•	•	•	•	•	•
	green POWER ON LED	•	•	•	•	•	•
	red SIGNAL LED	•	•	•	•	•	•
Setting:	DISCRETE push-button					•	•
	ANALOG push-button	•	•	•	•		
	MODE push-button	•	•	•	•	•	•
Ultrasonic emission frequency:	174 kHz		•	•		•	
	224 kHz	•	•			•	
Temperature drift:	< 0.02 % reading distance/°C	•	•	•	•	•	•
Repeatability:	0.1% reading distance					•	•
Resolution:	0.1% reading distance	•	•	•	•		
Linearity:	0.25% reading distance	•	•	•	•		
Minimum detection window:	10 mm					•	•
	100 mm	•	•	•	•		
Hysteresis:	2 mm					•	
	3 mm						•
Operating temperature:	-40 ... 70 °C	•	•	•	•	•	•
Storage temperature:	-40 ... 70 °C	•	•	•	•	•	•
Housing material:	PBT	•	•	•	•	•	•
Mechanical protection:	IP67	•	•	•	•	•	•
Connections:	M12 4-pole connector	•	•	•	•	•	•
Weight:	68 g	•	•	•	•	•	•
Standard reference:	EN 60947-5-2	•	•	•	•	•	•

READING DIAGRAMS

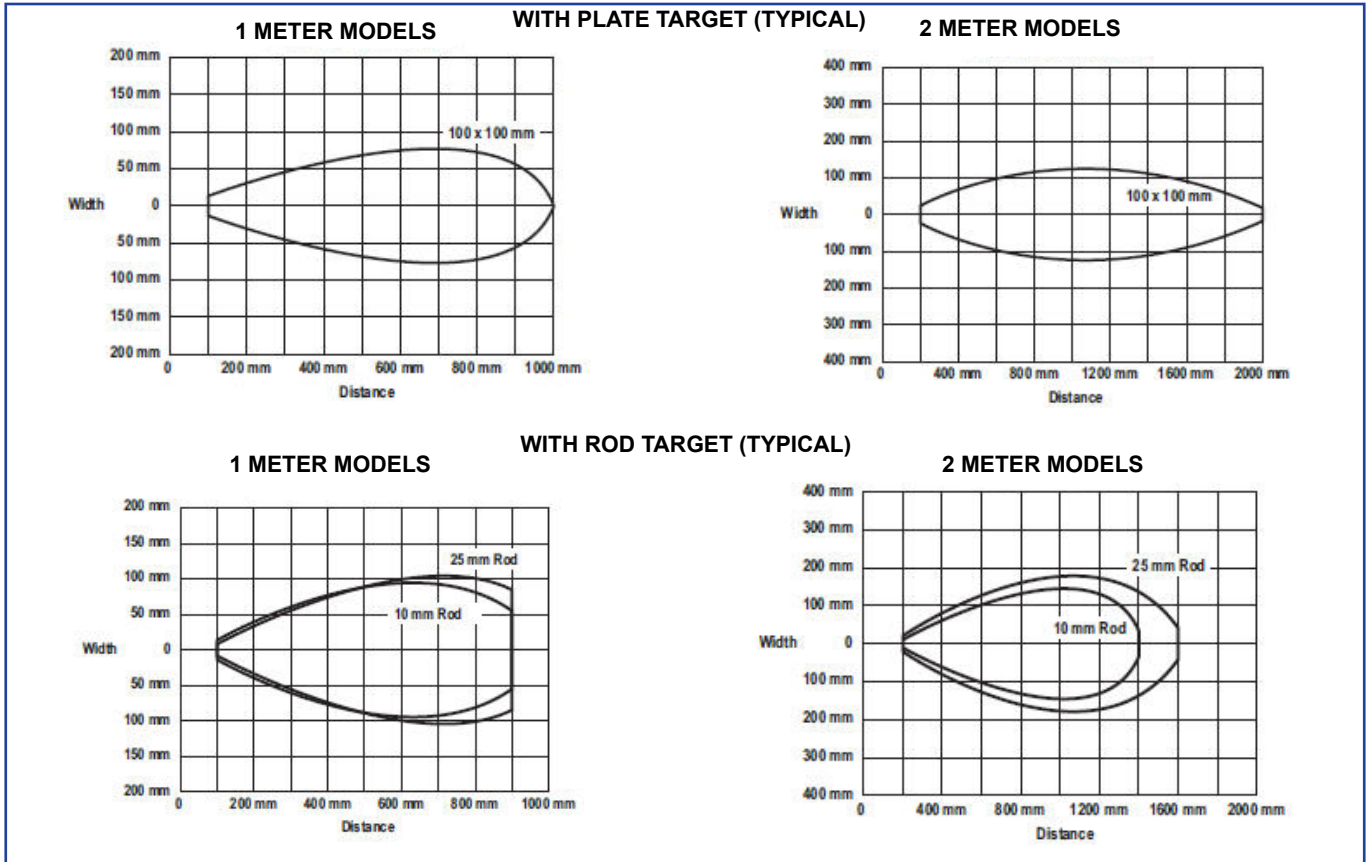

ANALOGUE OUTPUT DIAGRAMS

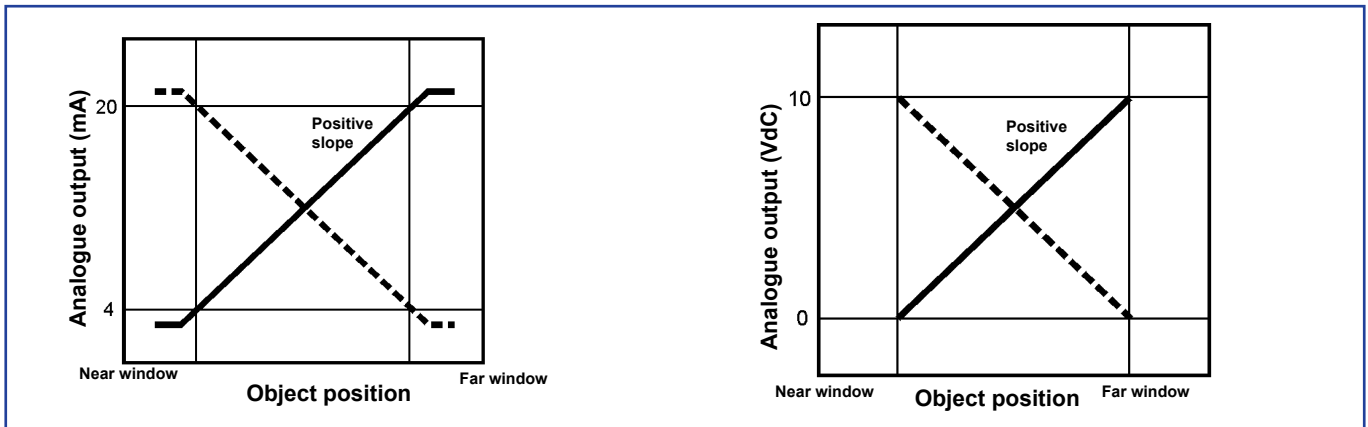

MODEL SELECTION AND ORDER INFORMATION

MODEL	OPERATING DISTANCE	OUTPUT	ORDER N°
US30-PR-5-N13-IH	100 ... 1000 mm	4-20 mA analogue	95B040060
US30-PR-5-N13-OH	100 ... 1000 mm	NPN e PNP	95B040100
US30-PR-5-N13-VH	100 ... 1000 mm	0-10 V analogue	95B040070
US30-PR-5-N23-IH	200 ... 2000 mm	4-20 mA analogue	95B040080
US30-PR-5-N23-OH	200 ... 2000 mm	NPN e PNP	95B040110
US30-PR-5-N23-VH	200 ... 2000 mm	0-10 V analogue	95B040090

The company endeavours to continuously improve and renew its products; for this reason the technical data and contents of this catalogue may undergo variations without prior notice. For correct installation and use, the company can guarantee only the data indicated in the instruction manual supplied with the products.